



TELEPHONE CONTROLLER WITH 13 MEMORIES AND 2-WIRE BUS

Key Features

- Low operating voltage
- Low current consumption, standby $\leq 0.1 \mu\text{A}$
- Oscillator using Xtal or ceramic resonator (3.58 MHz)
- Serial interface to external EEPROM
- Consistent, simple and usable procedures
- The settings are programmed via the keyboard and stored in EEPROM or set by pin options

Dialler:

- Data protection with 20 digit FIFO
- Sliding cursor protocol with comparison
- Automatic pause generation
- Temporary MF select via keyboard
- 30 digit LNR (Last Number Redial)
- 13 x 20 digit memory (RAM) on chip

Tone Ringer:

- Ring frequency discrimination
- 3 tone melody with 4 different repetition rates
- Volume of melodies can be set in 4 steps

Package

Available in 28 pin DIP and PLCC.

General Description

The AS2578 /B are a versatile repertory LD/MF diallers with a melody generator, a ring frequency discriminator and a 2-wire interface to EEPROM. Together with the AS2520/1, the AS2578 /B form a coherent basis for a fully electronic telephone with a wide range of options.

The AS2578 /B are especially designed to adapt to different PTT specifications. A RAM is on chip for last number redial, 3 direct dial and 10 numbers with abbreviated dialling. To allow easy use under a PABX, the device incorporates automatic pause insertion and sliding cursor procedure as selectable options (AS2578) or centrex keys (AS2578B). The device can be used with or without EEPROM as appropriate. When an EEPROM is connected, all RAM content is stored in the EEPROM by power loss.

The circuit provides the possibility to set different modes of operation (LM codes) via the keyboard or via pin options, e.g. default signalling mode, automatic pause insertion, flash or ground loop and settings of volume and melodies.

Block Diagramme

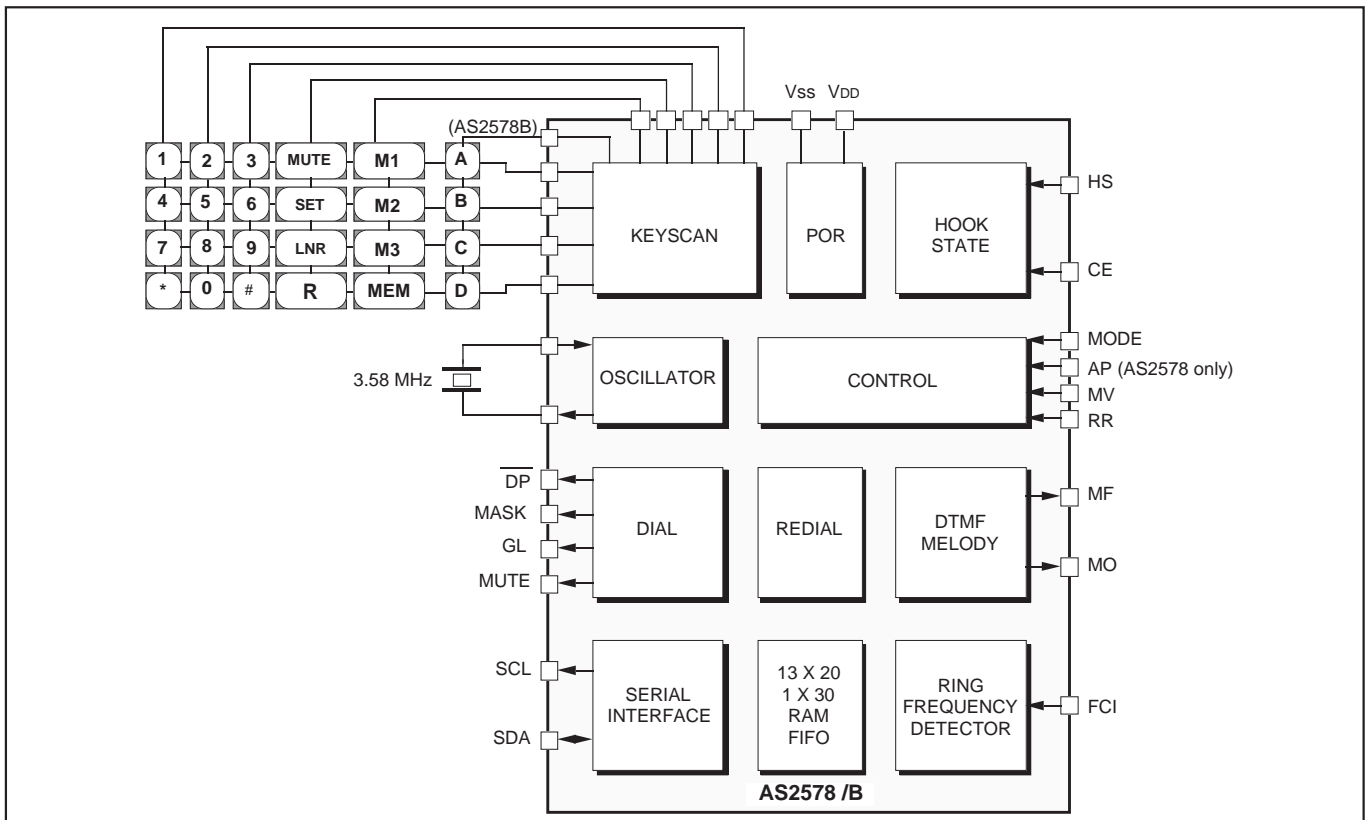

Pin Description

Pin #	Symbol	Function								
1 2 3 4	C4 C3 C2 C1	Keyboard Columns								
5	HS	Hook Switch Input This input is active high with internal pull-down resistor.								
6	MODE	Signalling (LD/MF) Default Mode Select Input <table border="1" data-bbox="486 703 1211 851"> <thead> <tr> <th>Mode pin</th> <th>Function</th> </tr> </thead> <tbody> <tr> <td>High</td> <td>LD default mode, make/break pulse 33/66 ms</td> </tr> <tr> <td>Open</td> <td>MF only</td> </tr> <tr> <td>Low</td> <td>LD default mode, make/break pulse 40/60 ms</td> </tr> </tbody> </table>	Mode pin	Function	High	LD default mode, make/break pulse 33/66 ms	Open	MF only	Low	LD default mode, make/break pulse 40/60 ms
Mode pin	Function									
High	LD default mode, make/break pulse 33/66 ms									
Open	MF only									
Low	LD default mode, make/break pulse 40/60 ms									
7	CE	Chip Enable Input This input is active high with internal pull-down resistor and is used to initiate setup procedures.								
8 9	OSC2 OSC1	Oscillator Input Oscillator Output Oscillator pins for Xtal or ceramic resonator (3.58 MHz). When a ceramic resonator is used a capacitor (10 - 22 pF) must be connected from each of the oscillator pins to V_{SS} .								
10	Vss	Negative Power Supply								
11	TONE	DTMF Tone Output The dual tones provided at this output have a level independent of the supply voltage in the operating range from 2.5 to 5.5V.								
13 14	SDA SCL	Serial Data I/O SDA is a bidirectional pin with an open drain with internal pull-up resistor and is used to transfer data into and out of a compatible EEPROM. Serial Clock Line Output The SCL output is an open drain with internal pull-up resistor and is used to clock data into and out of a compatible EEPROM.								
15	FCI	Frequency Comparator Input Schmitt trigger input for ring frequency discrimination.								
12	MO	Melody Generator Output Melodies for tone ringing are generated on this output. The output signal is PDM.								
16	MUTE	Mute Output This push-pull output is high during dialling and when mute key has been activated, otherwise low.								
17	MASK	Mask Output This push-pull output is high during pulsing (make and break periods).								

Continues...

Pin Description cont'd

Pin #	Symbol	Function												
18	DPN	Dial Pulse Output This is the push-pull output for controlling the hook-switch transistor. It is low during on-hook and break periods and high during off-hook (see timing diagrammes).												
19	GL	Ground Loop Output This push-pull output is high during ground loop												
20	VDD	Positive Power Supply												
21 22 23 24	R4 R3 R2 R1	Keyboard Rows												
25	C5	Keyboard Column (AS2578) This column is for the memory keys												
	C6	Keyboard Column (AS2578B) This column is for centrex keys (A - D keys). Automatic pause insertion and Temporary MF select 1 are fixed enabled (AP open)												
26	AP	Access Pause Select Input (AS2578) This input is used to select the automatic access pause insertion or sliding cursor (no centrex keys): <table border="1" data-bbox="480 1176 1445 1317"> <thead> <tr> <th>AP pin</th> <th colspan="2">Function</th> </tr> </thead> <tbody> <tr> <td>High</td> <td>Sliding cursor enabled</td> <td>Temporary MF select 2</td> </tr> <tr> <td>Open</td> <td>Automatic pause insertion enabled</td> <td>Temporary MF select 1</td> </tr> <tr> <td>Low</td> <td>Sliding cursor and pause disabled</td> <td>Temporary MF select 1</td> </tr> </tbody> </table>	AP pin	Function		High	Sliding cursor enabled	Temporary MF select 2	Open	Automatic pause insertion enabled	Temporary MF select 1	Low	Sliding cursor and pause disabled	Temporary MF select 1
	AP pin	Function												
High	Sliding cursor enabled	Temporary MF select 2												
Open	Automatic pause insertion enabled	Temporary MF select 1												
Low	Sliding cursor and pause disabled	Temporary MF select 1												
C5	Keyboard Column (AS2578B) This column is for the memory keys													
27	MV	Melody Volume Select Input This input is used to select the volume of the melodies in 4 steps by connecting the MV pin to row 1, 2, or 3. Leaving the pin open is the default setting (max. volume).												
28	RR	Repetition Rate Select Input This input is used to select the repetition rate of the melodies. 4 different rates can be selected by either leaving the pin open (default) or connecting it to column 1, 2, or 3.												

Note: "Open" means $\geq 100 \text{ k}\Omega$.

Power On Reset

The on chip power on reset circuit monitors the supply voltage (V_{DD}). As long as V_{DD} remains below the internal reference voltage, V_{ref} (typically 1.1V), the oscillator is inhibited. When V_{DD} rises above V_{ref} ($t_{RISE} = 1 \mu\text{s/V}$ to 50 ms/V), a reset signal is generated to assure correct start-up.

Initial Setup

A low to high transition on the CE input will initiate an automatic setup, i.e. the pin options are scanned and (when an EEPROM is connected) the stored LM codes and melody settings are read from the EEPROM. This is done independently of the hook state (see timing diagrammes).

Valid Keys

The keyscanning is enabled when CE or HS are high. During setup the keyboard is disabled. A valid key is detected from the keyboard by connecting the appropriate row to the column. This can be done using an n x m keyboard matrix with single contacts. Positive and negative edges of each contact are debounced. The debounce time is 15 ms.

Mute Key

The mute key is only enabled when off-hook. Depressing the mute key activates and deactivates (toggle switch) the MUTE output, when internal mute is inactive, i.e. in speech mode.

Any key entry overwrites a mute activated by the mute key, and mute will be deactivated.

Centrex Keys (AS2578B only)

The alphanumeric keys accommodate easy use of centrex services. The A, B, C and D keys are only valid in MF mode and are not storable. Pressing one of these keys will invoke the appropriate MF tones to be transmitted. The centrex keys are not stored in the RAM, but are buffered in the FIFO, and subsequently entered digits are also buffered in the FIFO.

Pressing the recall key after a sequence including centrex keys will reset the RAM counter, and subsequently entered digits will be stored in the RAM. If MF select (Set, *, Set) has been invoked once, then all subsequently entered digits/data will be buffered in the FIFO.

Memory Keys

The keys M1 to M3 are direct memory access keys and the MEM key is used for abbreviated dialling.

13 numbers can be stored in on chip RAM. Each number can contain up to 20 digits (including pauses).

If an EEPROM is connected to the serial bus, the content of the RAM is written into the EEPROM when CE is turned low indicating a power loss.

During programming multiple pauses can be inserted by pressing the LNR key.

Memory dialling is cascadable.

Mode Selection

The default mode (LD or MF) can be selected by the MODE pin.

Furthermore, the mode can be selected by setting the LM code (see setup menu). If no LM code is set, the mode will be determined by the MODE pin.

When default LD mode is selected, a temporary change to MF mode can be invoked by pressing * (AP = high, AS2578 only) or Set, *, Set.

When the circuit is in temporary MF mode, each of the following procedures revert it to default LD mode:

- pressing Set, *, Set ,
- pressing recall key (by further entries of the recall key the signalling mode will toggle between MF and LD,
- by next On-hook.

Last Number Redial

LNR is a facility that allows resigalling of the last manually dialled number without keying in all the digits again. The LNR is repeatable.

The current contents of the RAM are overwritten by new entries.

A manually entered number is automatically stored in the LNR RAM. The capacity of the RAM is 30 digits. If a number greater than 30 digits is entered, the LNR facility will be inhibited (until new entries < 31 digits) and further entries will be buffered in FIFO.

Postdialled digits, i.e. digits manually entered after LNR has been invoked, are not stored in RAM but buffered in FIFO.

Recall Function

A recall activation will invoke a flash (timed loop break) or a ground loop (GL) depending on the selected LM code, which is stored in the external EEPROM (see setup menu).

If no LM code is set, depressing the recall key will invoke both a flash and a GL, however, in LD mode a Flash is never executed.

If recall is the first entry in a digit string, it will be stored in LNR RAM when digit(s) are entered after the recall.

If the recall key is depressed after a digit string has been entered or dialled out, the recall will not be stored, and subsequently entered digits will be stored in the LNR RAM as the new number.

If pressing the recall key is not followed by digit entries, the LNR RAM remains intact.

After a recall a pause will automatically be generated. The pause time is 3 sec.

The ground loop (GL) has two pulse lengths, namely a short of 500 ms and a long of 1250 ms.

Short GL: If the recall key is depressed for ≤ 540 ms, the GL pulse is 500 ms.

Long GL: If the recall key is depressed for > 540 ms, the GL pulse is 1250 ms.

During redial a ground loop is only executed as a long GL (1250 ms).

Pause Generation

Pause introduces a delay in signalling digit strings to accommodate second and subsequent dial tones.

Automatic pauses are generated in the following manner:

- always after a recall independent of the AP pin
- with automatic pause insertion enabled by pin option or LM code, up to two pauses can be automatically inserted at any location of the original entry in the RAM (except location 1 of the digit string), when the mute output goes inactive (in MF mode for more than 1 sec.) before next entry.

A pause read from the RAM can be terminated (shortened) prior to time out by a low level on AP pin (AS2578 only) during the pause execution. The pause time is 3 sec.

During execution of a pause, mute is inactive, i.e. the circuit is in speech mode.

Sliding Cursor Procedure (AS2578 only)

To accommodate redialling (LNR) behind a PABX without using automatic pause generation, a sliding cursor protocol is implemented. The sliding cursor is enabled when AP = high. If new entries match the previous RAM contents, pressing the LNR key will dial out the remaining digits.

If there is an error in matching, the LNR will be inhibited until next on-hook, and the RAM will contain the new number.

Serial Interface

The AS2578 /B support a bidirectional bus oriented

protocol. The protocol defines any device that sends data onto the bus as a transmitter, and the receiving device as the receiver. The AS2578 /B are controlling the transfer and hence the master. The EEPROM being controlled is the slave.

The AS2578 /B will always initiate data transfer, and provide the clock for both transmit and receive operations. Therefore, the protocol is for single master applications only.

However, a temporary second master can be used to write into the EEPROM when the AS2578 /B are supplied and in idle state.

Clock and Data Conventions

Data states on the SDA line can change only during SCL low. SDA state changes during SCL high are reserved for indicating start and stop conditions (see figure 1 and 2).

Start Condition

All commands are preceded by the start condition, which is a high to low transition of SDA when SCL is high. The slave should continuously monitor the SDA and SCL lines for the start condition and must not respond to any command until this condition has been met.

Stop Condition

All communications are terminated by a stop condition, which is low to high transition of SDA when SCL is high. The stop condition is also used to place the slave in the standby power mode.

Acknowledge

Acknowledge is a software convention used to indicate successful data transfers. The transmitting device, either master or slave, will release the bus after transmitting eight bits. During the ninth clock cycle the receiver will pull the SDA line low to acknowledge that it received the eight bits of data (see figure 3).

The slave should always respond with an acknowledge after recognition of a start condition and its slave address. If both the device and a write operation have been selected, the slave should respond with an acknowledge after receipt of each subsequent eight bit word.

In the read mode, when the EEPROM has transmitted eight bits of data, it should release the SDA line and monitor the line for an acknowledge. If the AS2578 /B respond with an acknowledge and does not generate a stop condition, the EEPROM should continue to transmit data. If the AS2578 /B do not respond with an acknowledge, the EEPROM should terminate further

data transmission and await the stop condition to return to the standby power mode.

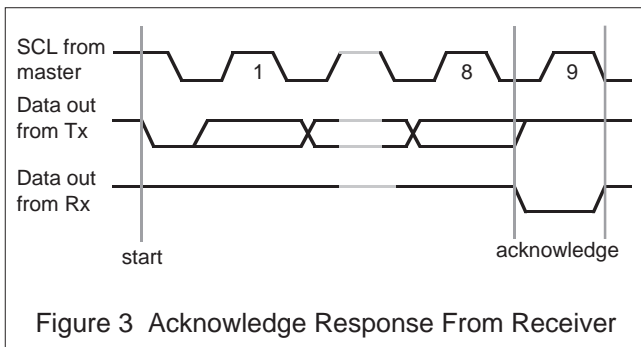
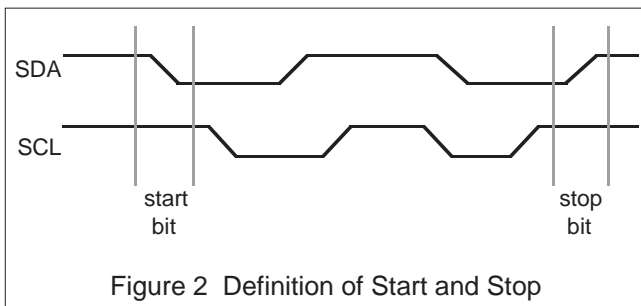
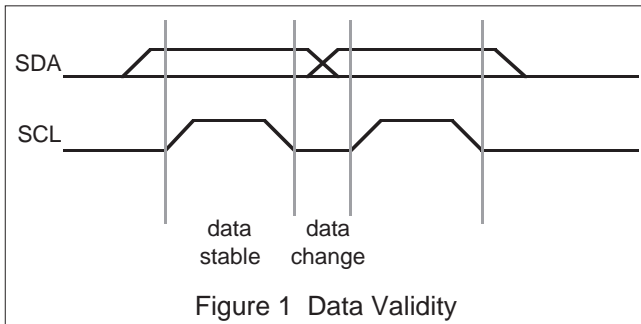

Frequency Comparator

The frequency comparator monitors that the ring signal is in the limits as shown in figure 4.

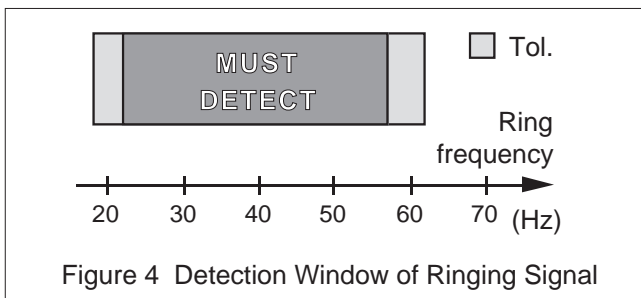

When a continuous valid ring signal is present for 80 ms, the melody generator is activated and remains active until two or more periods of the ring signal are missing.

Tone Generator

The tone generator incorporates the DTMF tones and 3 basic frequencies for the tone ringer.

DTMF

The DTMF generator provides 8 frequencies, namely:

Low group

Row 1	697 Hz
Row 2	770 Hz
Row 3	852 Hz
Row 4	941 Hz

High group

Col. 1	1209 Hz
Col. 2	1336 Hz
Col. 3	1477 Hz
Col. 6	1633 Hz (AS2578B only)

The MF tones are in accordance with CEPT recommendations.

Tone Ringer (Melody)

The three basic frequencies of the melodies are:

F1 = 800 Hz, F2 = 1067 Hz, and F3 = 1333 Hz ($\pm 5\%$).

The repetition rate can be set via key procedures or by pin options as follows:

LM code	Repetition rate
1	1 time (50 ms pause)
2 (default)	4 times
3	7 times
4	10 times

Repetition rate means that a sequence of 6 frequencies is repeated 1 to 10 times within 1 sec. For LM code 1 a pause of 50 ms is inserted between the frequencies to allow a better recognition of the melodies.

The sequence of the frequencies is controlled by the sequence register as follows:

Sequence F1 F2 F3 F1 F2 F3 ...

The volume of the melodies (MO output) can be set as follows:

LM code	Volume	Steps
1	- 17.5 dB	
2	- 11.5 dB	6 dB
3	- 5.5 dB	6 dB
4 (default)	0 dB	5.5 dB

LM Codes and Pin Options

LM code	Pin option	Function
02-2*	AP = L	Automatic pause insertion: off Sliding cursor: off MF select 1
02-3	AP = Hi-Z	Automatic pause insertion: on Sliding cursor: off MF select 1
-	AP = H	Automatic pause insertion: off Sliding cursor: on MF select 2
033*	MODE = L	LD mode 40/60 GL
033*	MODE = H	LD mode 33/66 GL
036	-	MF mode GL
037	-	MF mode Flash
-	MODE = Hi-Z	MF mode GL + Flash
250	-	Resets all user settings to default and clears all RAM contents
258	-	Clears all RAM contents
5 - 4*	MV = Hi-Z	Melody volume: 0 dB
5 - 3	MV = R3	Melody volume: - 5.5 dB
5 - 2	MV = R2	Melody volume: - 11.5 dB
5 - 1	MV = R1	Melody volume: - 17.5 dB
6 - 1	RR = Hi-Z	Repetition rate: 1 time (50 ms pause)
6 - 2*	RR = C1	Repetition rate: 4 times
6 - 3	RR = C2	Repetition rate: 7 times
6 - 4	RR = C3	Repetition rate: 10 times

Note 1: Programming an LM code overwrites pin options, however, LM code 033 can only be selected when the MODE pin is connected to either high or low for selecting the make/break ratio. Not valid LM codes are ignored. LM codes with a '*' are default settings.

Note 2: When the AP pin is pulled low during execution of a pause, the pause will be terminated.

Note 3: AP pin option not available on AS2578B.













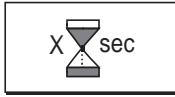

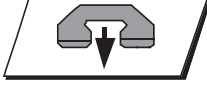
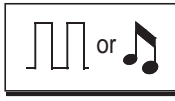

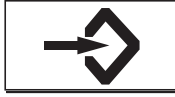

Operating Procedures

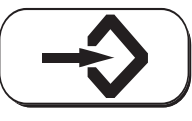
Procedure Principles

The procedures for utilizing the features of the AS2578 /B are optimized out of consideration for the human factor in order to:

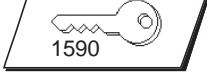
- meet the user's expectations
- be easy to learn and relearn
- not invoke any automatic functions which the user doesn't expect
- protect the user from committing critical errors, e.g. dialling wrong numbers, etc.
- be consistent, simple and usable
- meet the German 1 TR 2 and ETR 2 specifications.

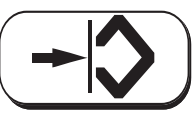
Symbols

<u>States:</u>	<u>Entries:</u>	<u>Processing:</u>
 Idle (on-hook, no ringing)	 Going off-hook	 Time out (x sec.)
 Ringing	 Going on-hook	 Dialling (LD or MF)
 Speech mode	 Pressing a key	 Storing (writing into RAM or EEPROM)
 Privacy mute	 Entering a number	 Processing according to text
 Programming	 Entry according to text	 Melodies activated (ringing)
 False programme entry	 Enter password	 = reading from memory
 Invalid entry		
 State according to text		

Setup Procedures

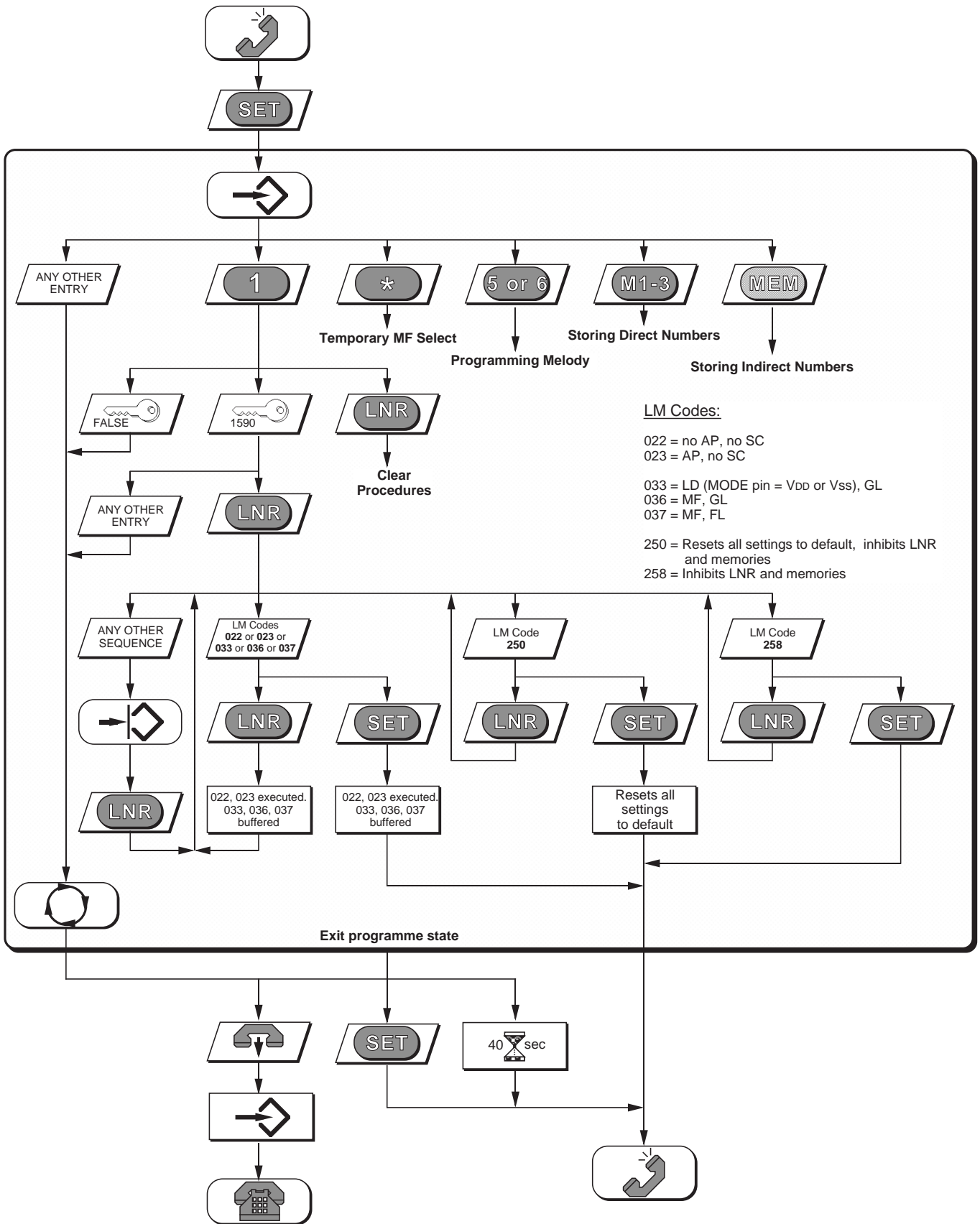

Clear Procedures

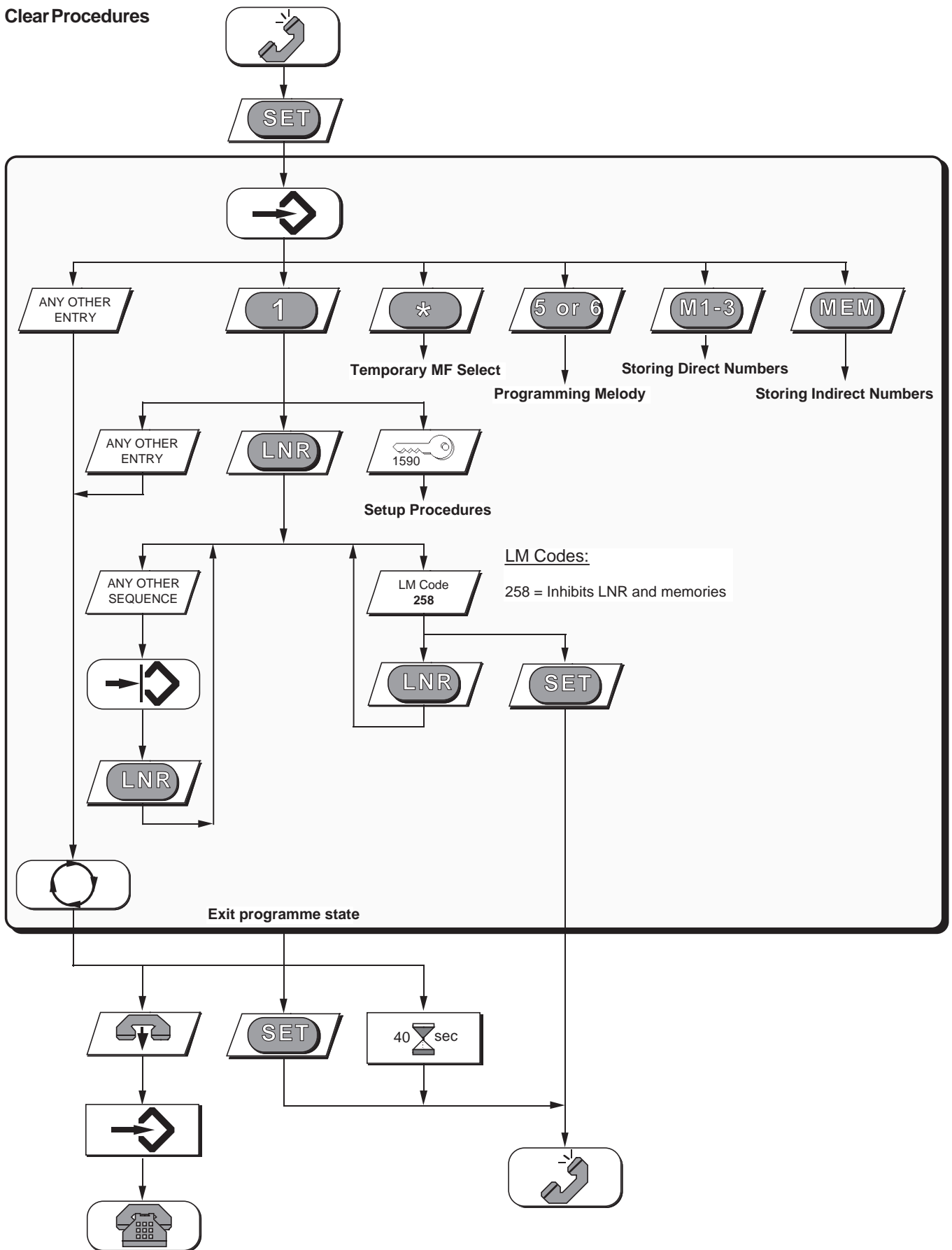

Programming Melody

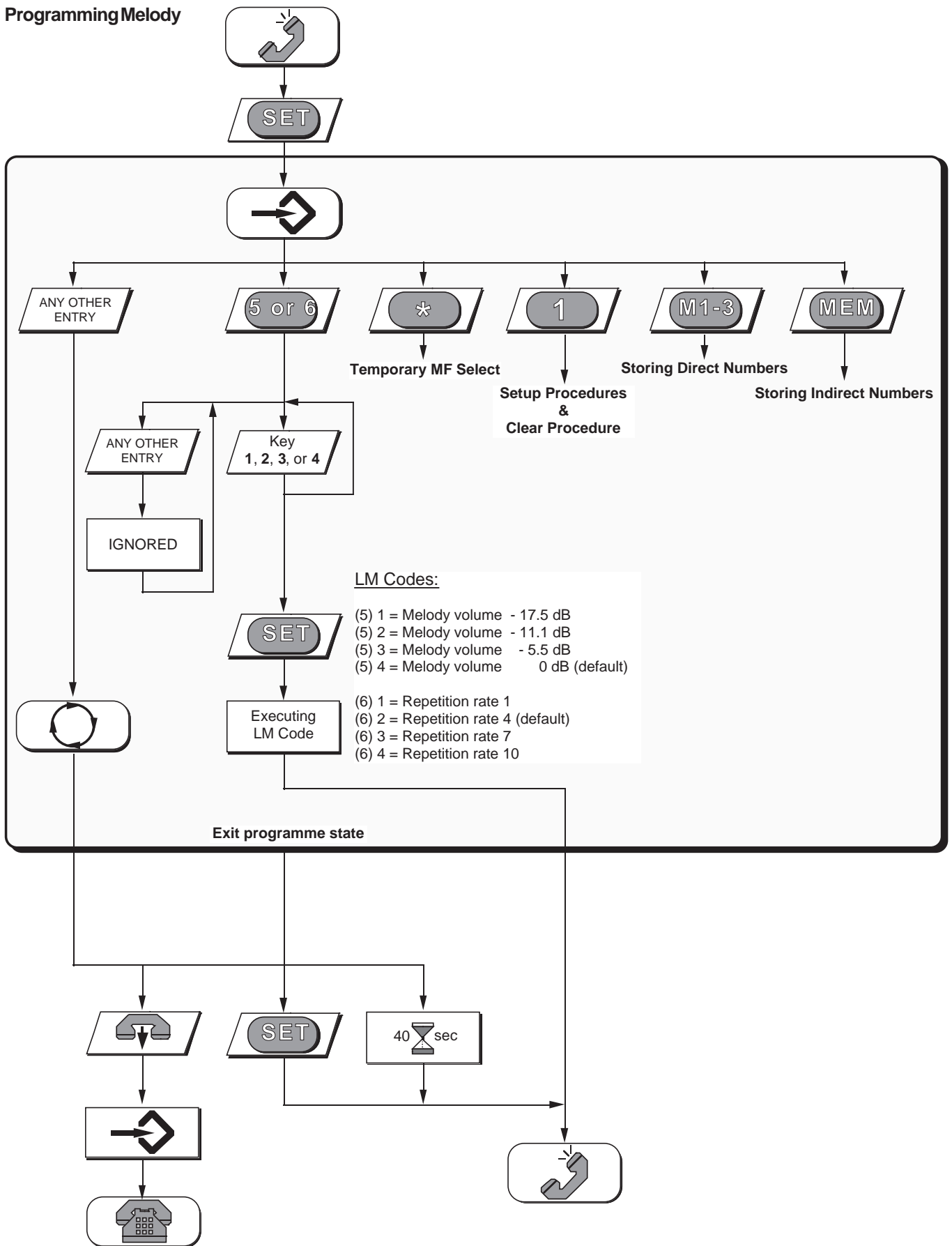

Programming Volume of Melody During Ringing

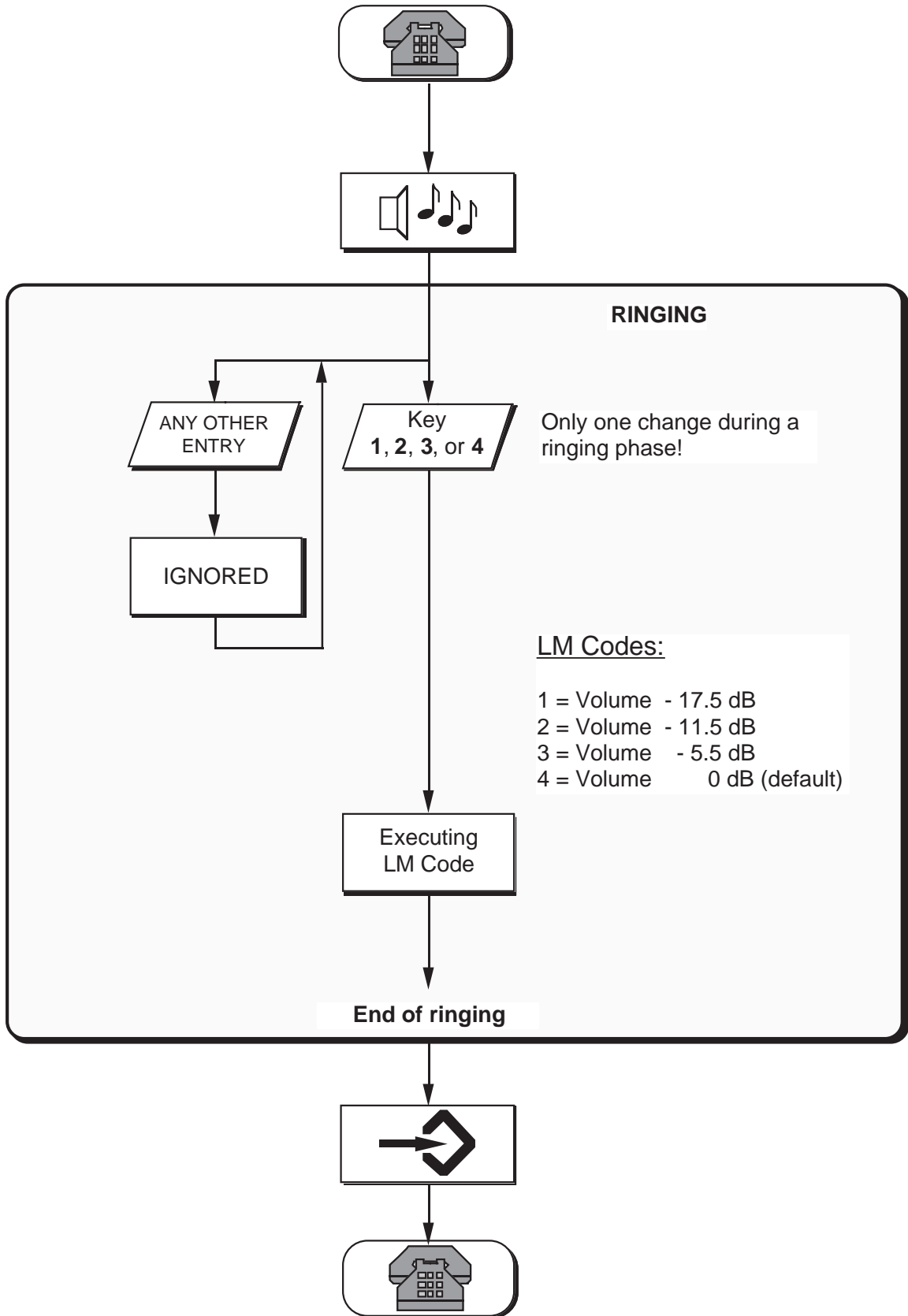

Temporary MF Select 1

(AP pin = open or low)

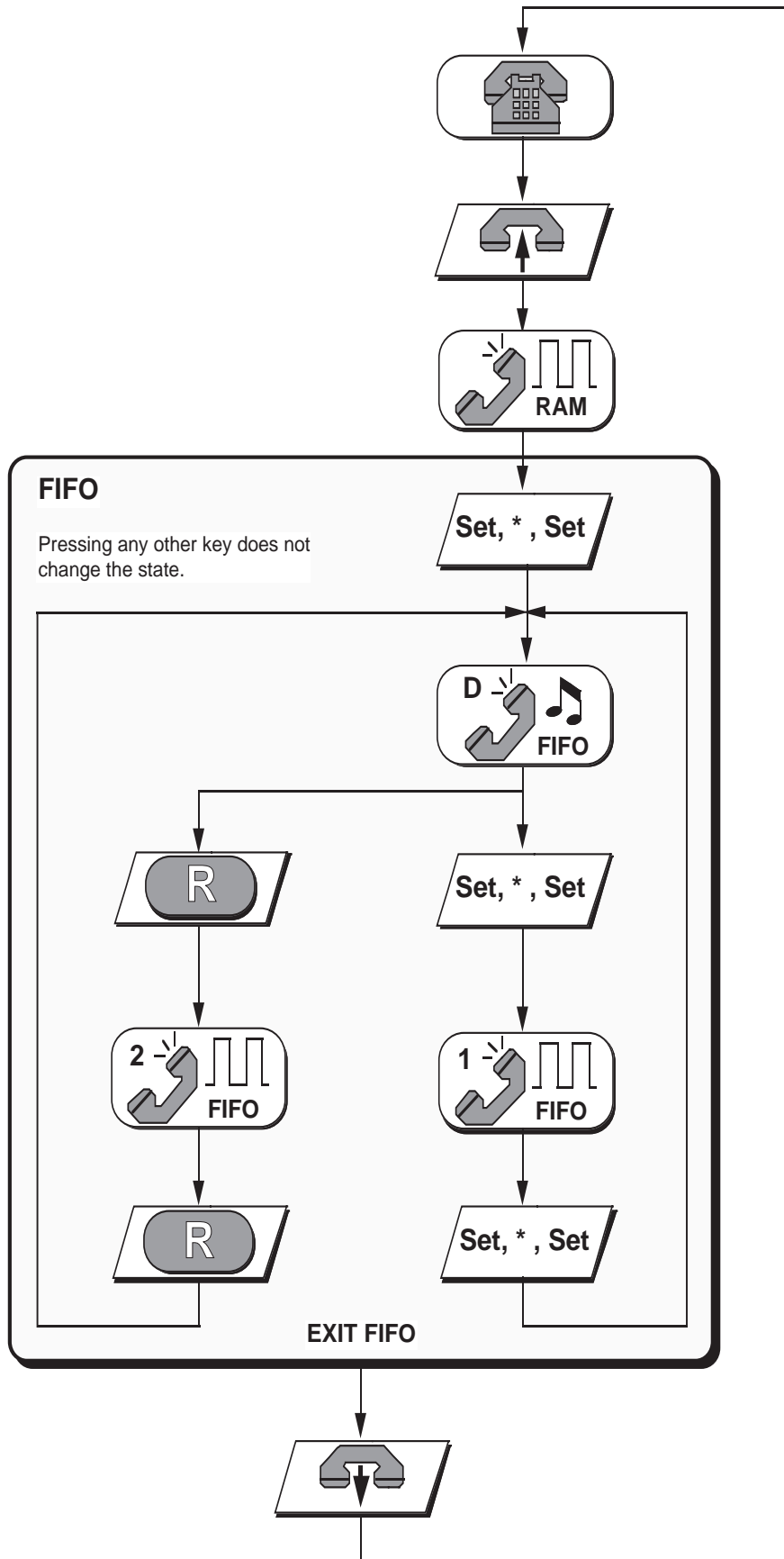

Automatic Dialling

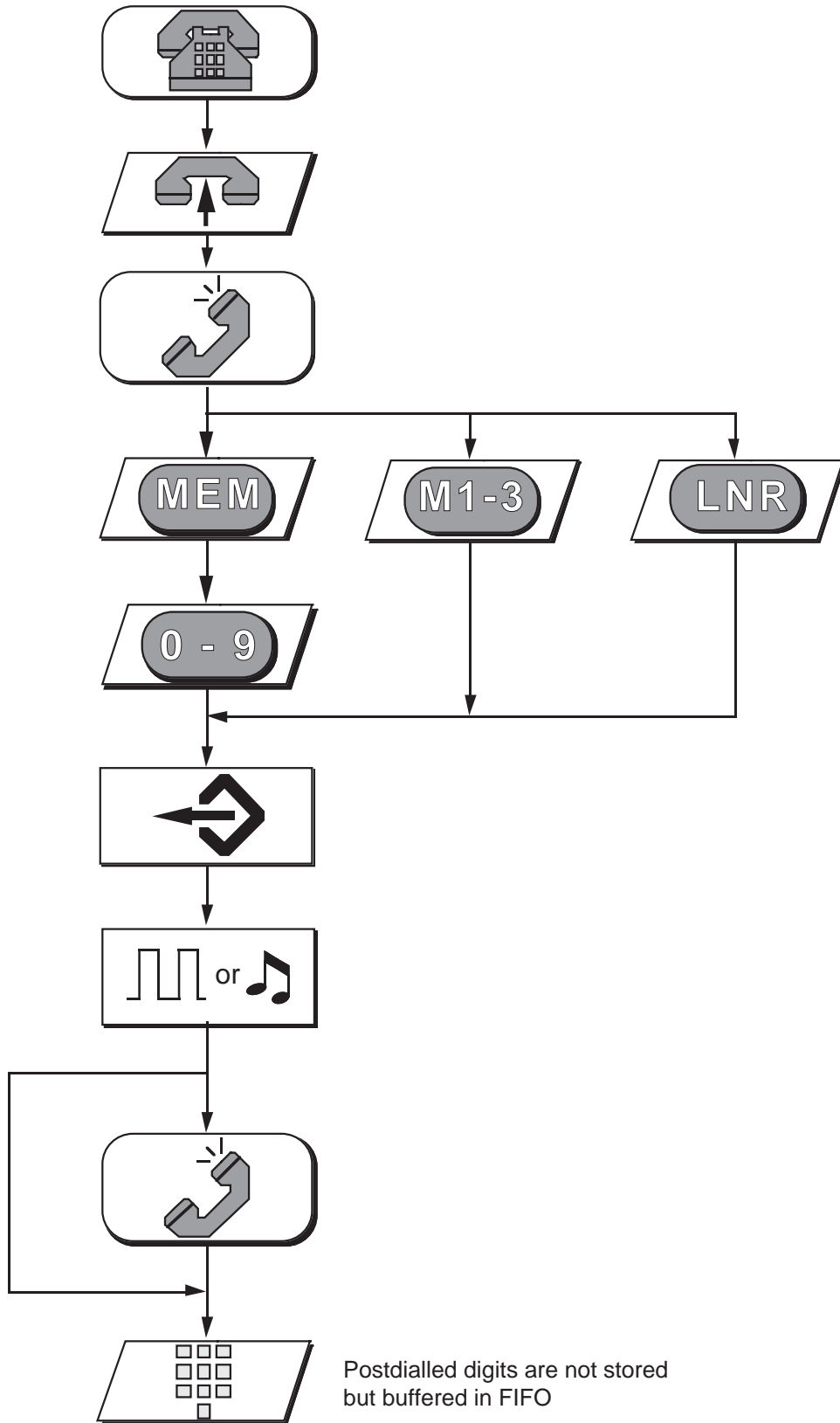

Storing Numbers

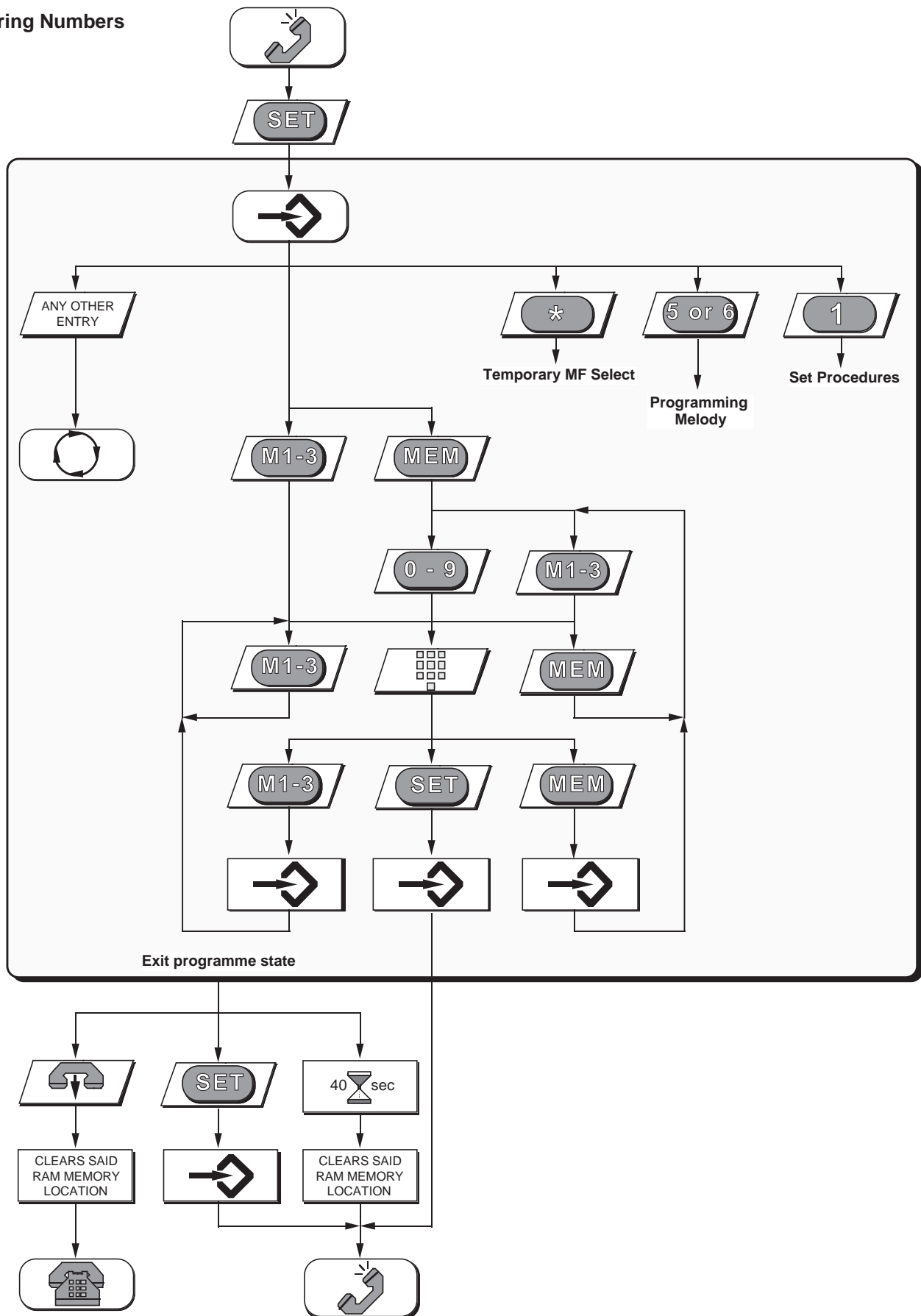

Privacy Mute

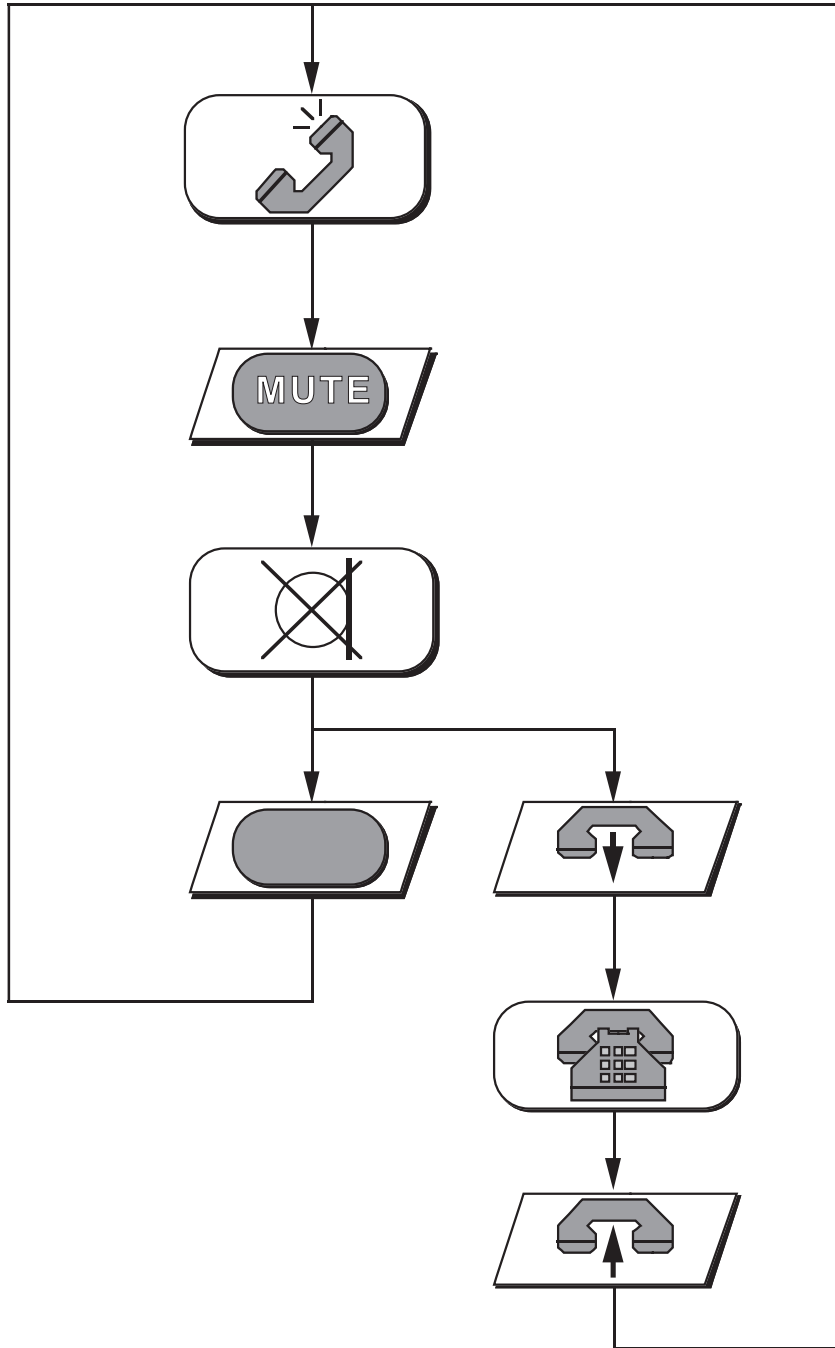

Timing Diagrammes

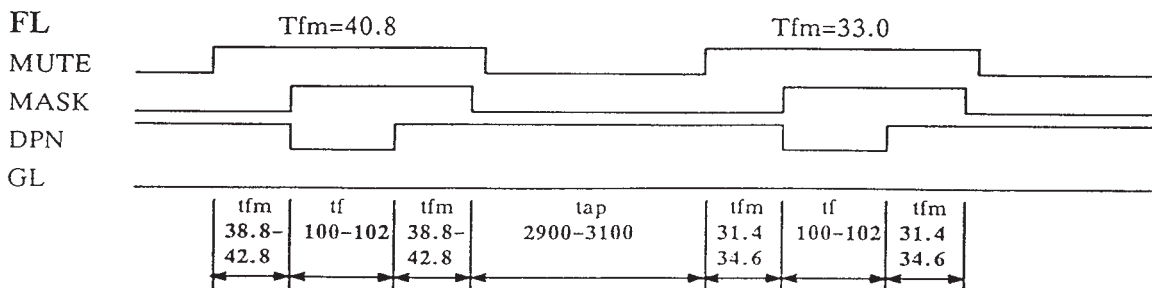
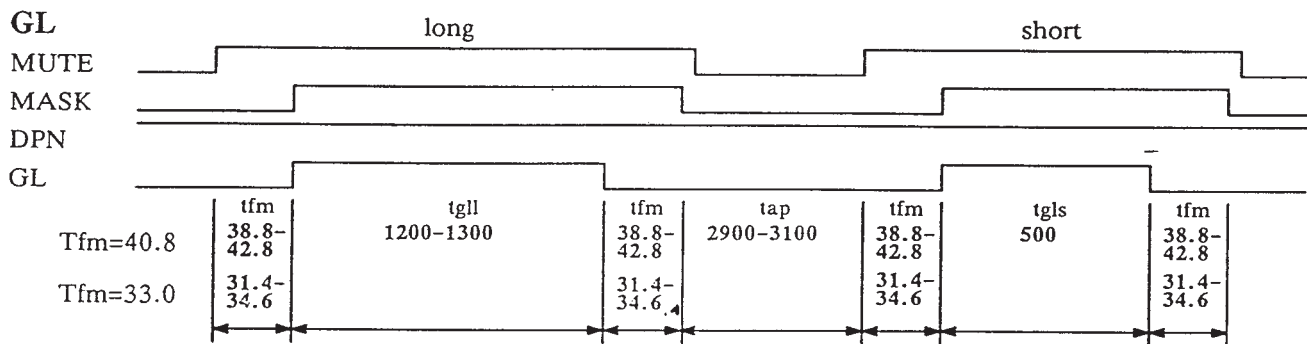
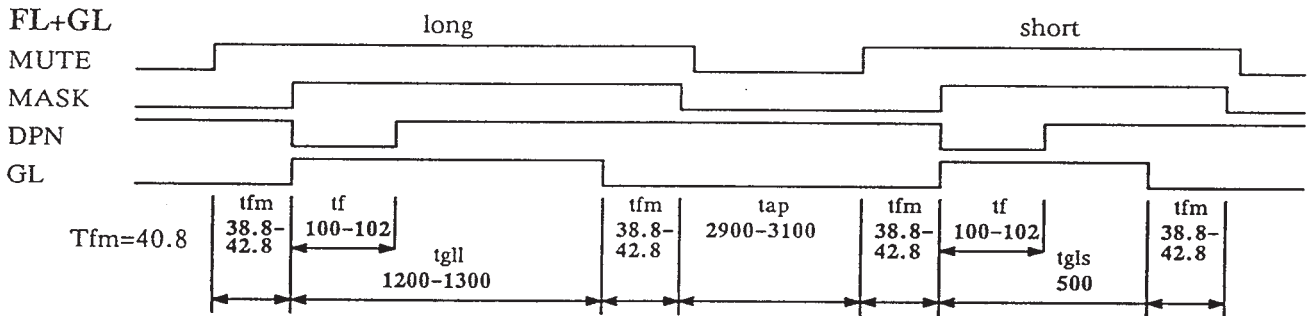
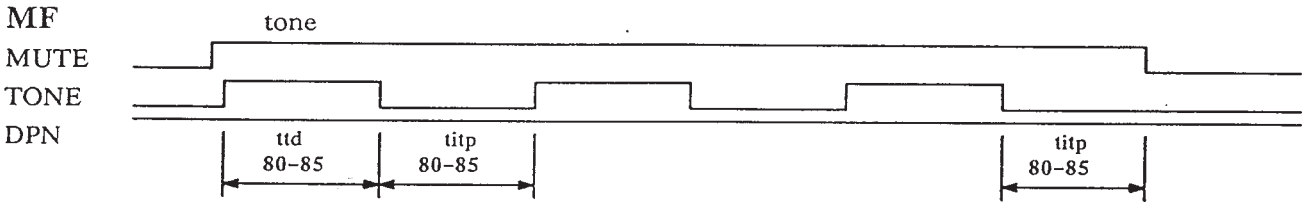
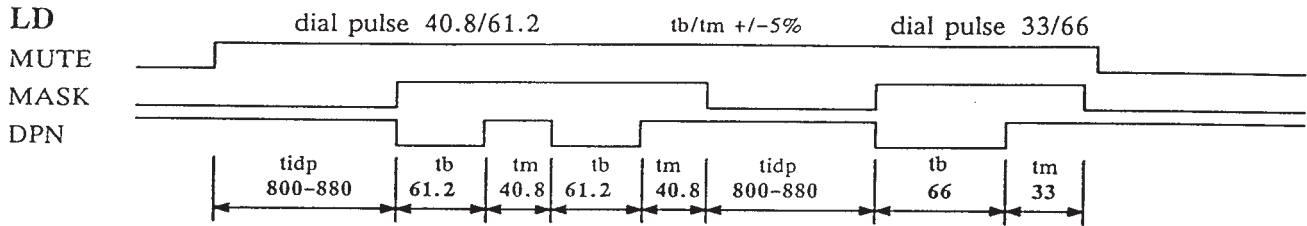

Note: all timing values in ms

Electrical Characteristics

Absolute Maximum Ratings

Positive Supply Voltage	$-0.3V \leq V_{DD} \leq 7V$
Input Current	$\pm 25 \text{ mA}$
Digital Input Voltage	$V_{SS} - 0.3V \leq V_{IN} \leq V_{DD} + 0.3V$
Electrostatic Discharge (HBM)	$\pm 800V$
Storage Temperature	-65°C to $+125^{\circ}\text{C}$

Recommended Operating Conditions

Supply Voltage (except DTMF)	$2.2V \leq V_{DD} \leq 5.5V$
Supply Voltage (DTMF)	$2.5V \leq V_{DD} \leq 5.5V$
Oscillator Frequency	3.58 MHz
Operating Temperature	-25°C to $+70^{\circ}\text{C}$

DC Characteristics (Default conditions: recommended operating conditions; outputs unloaded; $V_{DD} = 3.5V$;
AP and MODE = Vss; unless otherwise specified))

Symbol	Parameter	Conditions	Min	Typ	Max	Units
I_{DD0}	Standby Current	HS = L; CE = L			0.1	μA
I_{DD}	Standby Current	HS = H; Osc. = 0			3.6	μA
I_{DD}	Operating Current	no tones		400	700	μA
I_{DD}	Operating Current	MF/melody		0.9	1.5	mA
V_{IL}	Input Voltage, Low		V_{SS}		$0.2 V_{DD}$	V
V_{IH}	Line Voltage, High		$0.8 V_{DD}$		V_{DD}	V
I_{OL}	Output Current, Sink	$V_{OL} = 0.4V$	1.5			mA
I_{OH}	Output Current, Source	$V_{OH} = V_{DD} - 0.4V$	1			mA
R_{HS}	Pull-down Resistor		1			$\text{M}\Omega$
R_{CE}	Pull-down Resistor		1			$\text{M}\Omega$

AC Characteristics (Default conditions: recommended operating conditions)

Symbol	Parameter	Conditions	Min	Typ	Max	Units
t_s	Clock Startup Time				5	ms
t_d	Key Debounce Time			14.7		ms
t_{HS}	HS Debounce Time			14.7		ms
t_{SU}	Setup Time				100	ms

Continues...

AC Characteristics Cont'd

Symbol	Parameter	Conditions	Min	Typ	Max	Units
V_{MF}	DTMF MF Tone Level	High group, $R_L = 15\text{ k}\Omega$	-12.3	-10.8	-9.3	dBm
ΔV_{L-H}	Preemphasis Low to High	$R_L = 15\text{ k}\Omega$	2.0	2.4	2.8	dB
THD	Distortion (0.3 - 4 kHz)	$R_L = 15\text{ k}\Omega$, note 3			-23	dBr
t_{TD}	Tone Duration	Note 1	80	82.3	85	ms
t_{ITP}	Inter Tone Pause	Note 1	80	82.3	85	ms
t_{TR}	Tone Rise Time	Note 2			5	ms
t_{TF}	Tone Fall Time	Note 2			5	ms
t_{DR}	LD Dial Rate	$\pm 5\%$		10		pps
t_{MB}	Make/Break Period	$\pm 5\%$, MODE = low $\pm 5\%$, MODE = high		40.8/61.2 33/66		ms ms
t_{IDP}	Inter Digit Pause		800	840	880	ms
t_{MO}	Mute Overhang			t_M		
t_{FD}	Flash Duration		100		102	ms
t_{GLS}	Ground Loop, Short	R key $\leq 540\text{ ms}$	495	500	505	ms
t_{GLL}	Ground Loop, Long	R key $> 540\text{ ms}$	1200	1250	1300	ms
t_{AP}	Automatic Pause		2.9	3.0	3.1	sec
V_{MO}	Melody Melody Output			PDM		
t_{MD}	Melody Delay				10	ms
F1	Frequency 1		770	800	830	Hz
F2	Frequency 2		1025	1067	1110	Hz
F3	Frequency 3		1280	1333	1385	Hz
t_{DT}	Detection Time		80		85	ms
t_{TO}	Detection Time-out			note 4		ms
f_{MIN}	Min. Detection Frequency		19	20	21	Hz
f_{MAX}	Max. Detection Frequency		58	59	60	Hz

Note 1: The values are valid during automatic dialling and are minimum values during manual dialling, i.e. the tones will continue as long as the key is depressed.

Note 2: The rise time is the time from 10% of final value till the tone amplitude has reached 90 % of its final value.

Note 3: Relative to high group.

Note 4: The FCI circuit is reset by POR and on-hook. After a reset the FCI circuit is in a standby state. A positive edge on FCI will start the 73 ms timer and the frequency discrimination is initiated. Whenever a period of the ring frequency is missing, the timer is reset. When a valid ring signal is present for $\geq 73\text{ ms}$, the melody generator is started and is directly controlled by a valid signal from the FCI circuit. This condition will remain until a new reset.

Ordering Information:

Part Number	Package	Pin 25	Pin 26
AS2578 P	28 pin DIP	C5	AP
AS2578 N	28 pin PLCC	C5	AP
AS2578B P	28 pin DIP	C6	C5
AS2578B N	28 pin PLCC	C6	C5

Applications:

For application support contact your local AMS sales office.

Devices sold by Austria Mikro Systeme are covered by the warranty and patent indemnification provisions appearing in its Term of Sale. Austria Mikro Systeme makes no warranty, express, statutory, implied, or by description regarding the information set forth herein or regarding the freedom of the described devices from patent infringement. Austria Mikro Systeme reserves the right to change specifications and prices at any time and without notice. Therefore, prior to designing this product into a system, it is necessary to check with Austria Mikro Systeme for current information. This product is intended for use in normal commercial applications. Applications requiring extended temperature range, unusual environmental requirements, or high reliability applications, such as military, medical life-support or life-sustaining equipment are specifically *not* recommended without additional processing by Austria Mikro Systeme for each application.

Copyright © 1995-7, Austria Mikro Systeme International AG, Schloss Premstätten, 8141 Unterpremstätten, Austria. Trademarks Registered®. All rights reserved. The material herein may not be reproduced, adapted, merged, translated, stored, or used without the prior written consent of the copyright owner.